

SWISSPEARL

Cemsix 6" Profile

Agricultural, Industrial Roofing & Cladding



Swisspearl GB Ltd.

Warehouse 145, Stretton Green Distribution Park
Langford Way
Appleton, WA4 4TQ
+44 (0) 203 372 2300
info@gb.swisspearl.com

swisspearl.com

Swisspearl Cemsix fully compressed fibre cement sheet - the traditional 6 inch profile - can be used as a replacement on existing farm buildings, already incorporating 6 inch profile, without the need for changing purlin spacings.

Fibre cement sheeting is the ideal material for all single skinned agricultural buildings.

Swisspearl companies have been manufacturing corrugated sheets since 1910. With over a century of production in fibre cement roofing and cladding, we are able to draw on experience of installation across the whole of Europe.

Combined with the latest technological advances, our fully accredited system of sheets allows designers to clad agricultural or industrial buildings in a Class A2-s1,d0 fire rated, rust and rot-proof material with a proven track record of reliability, quality and durability.

Manufactured using Portland cement, together with a formulation of superior blended synthetic and cellulose fibres, reinforced with strengthening strips and available with superior colouration systems, Cemsix has been produced to the highest European standards for decades and is available, ex-stock, throughout the UK.



1. Improved manufacturing process gives better consistency of sheets

Manufacturing

Fully compressed Cemsix corrugated sheets are manufactured on state of the art, modern production lines to ensure the highest quality, most durable products.

- 1. Improved manufacturing processes**
With the latest technology and manufacturing equipment, our presses have a 75 kg/cm² tonne compression capability to increase density and consistency of sheets.
- 2. Superior colouration**
a&b The Swisspearl 3-part process offers a consistent and visually appealing finish incorporating a coloured primer and top coat (see also page 7).
- 3. Higher tolerances**
Advanced and manufacturing processes offer higher working tolerances, as further compressed material affords more accurate dimensional tolerances
- 4. Minimal damp patches**
The incidence of visible and unsightly discolourations on the undersides of sheets is inhibited.

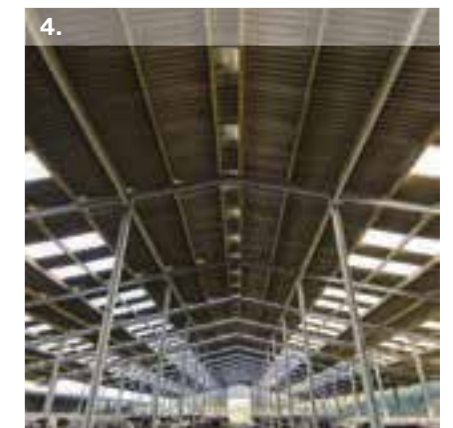
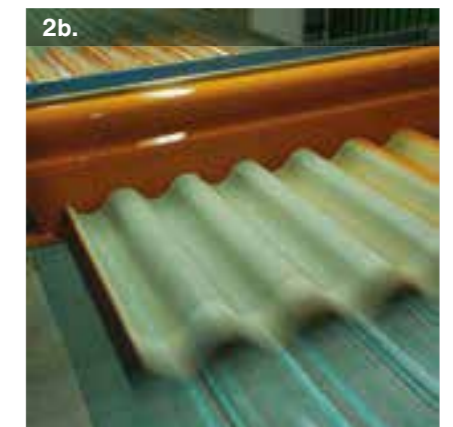

- 5&6. Denser material and an enhanced pore structure**
Denser material offers further resistance to abrasion and wear, especially at fixing positions.

A more even pore structure means that moisture is absorbed more easily and evenly across the sheet. Sheets can hold up to 15% of their volume as water vapour.

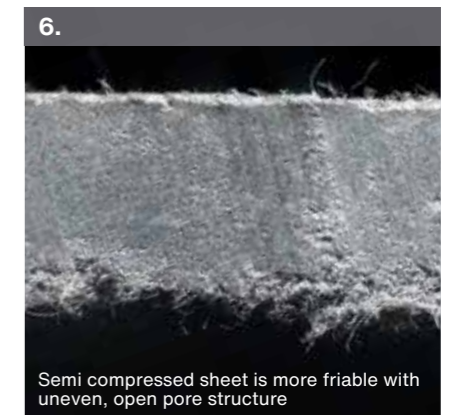
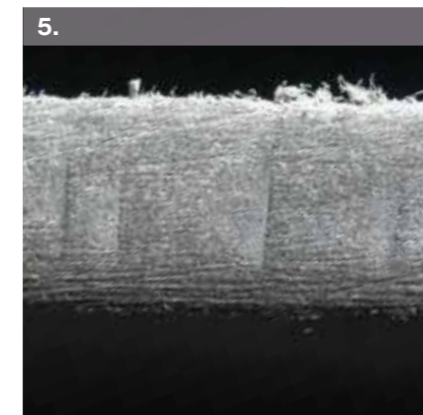

Semi compressed sheet is more friable with uneven, open pore structure



Quality Assurance

Cemsix corrugated sheets are manufactured in accordance with a quality assurance system to BS EN ISO 9001:2015 and to the requirements of BS EN 494:2012 +A1:2015.

Cemsix has been awarded the BBA Certificate Number 03/4049 for sheets and matching ridges, cranks, bargeboards and other accessories.



Institut Bauen und Umwelt e.V.

Environment

Cemsix corrugated sheets are manufactured in accordance with the requirements of BS EN ISO 14001:2015

An Environmental Product Declaration (EPD) complying with EN 15804+A2 for corrugated sheets, has been awarded by the IBU.



Agricultural livestock: Cemsix Natural Grey



Food production: Cemsix Painted



Industrial biodigestion site: Cemsix Natural Grey



Leisure facility: Cemsix Painted

Cemsix in action



Agricultural general purpose: Cemsix Painted

Cemsix corrugated sheets

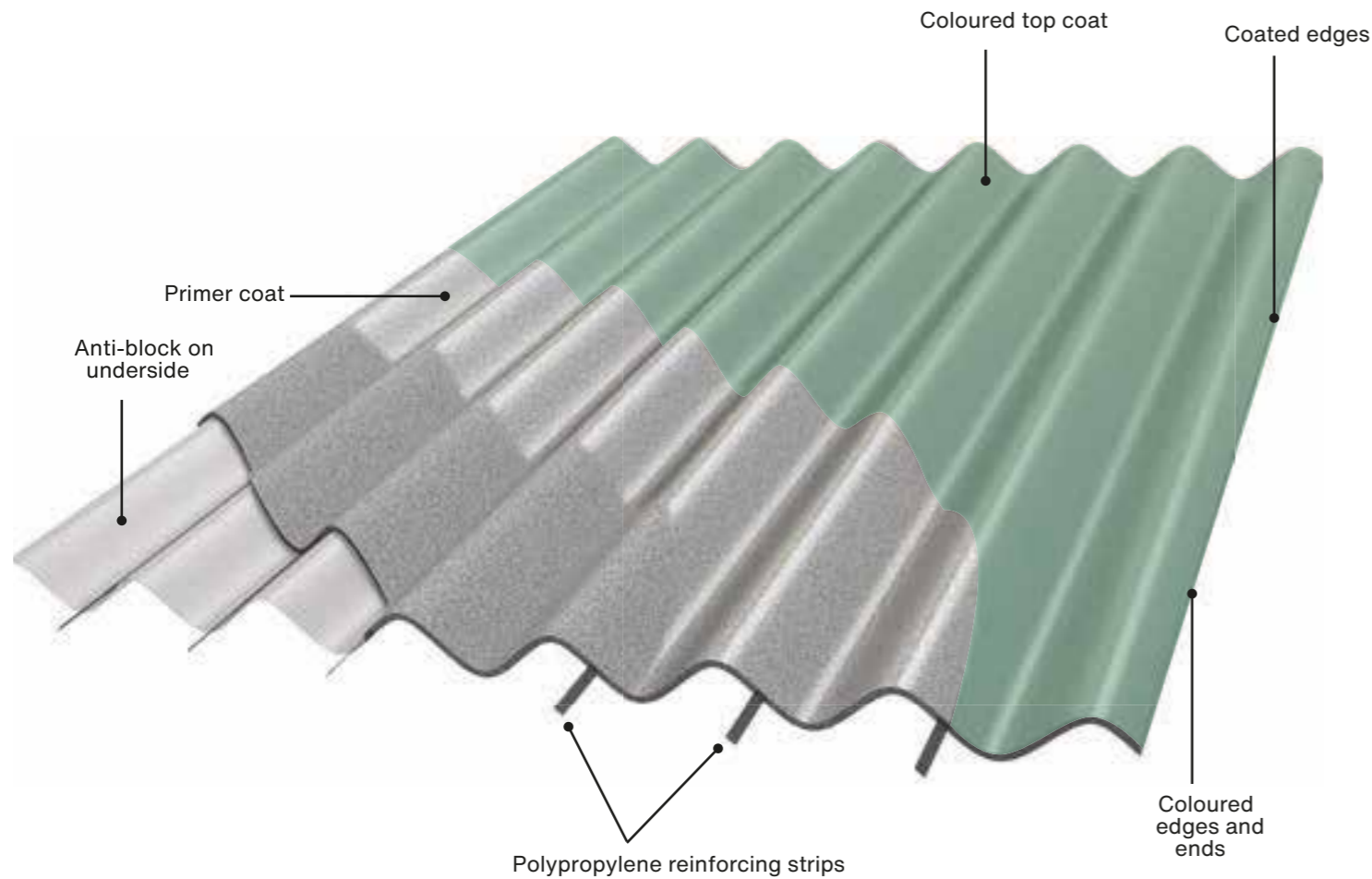

Colours

Produced in the traditional 6" UK profile with 6 corrugations and overlaps/underlaps on both sides of the sheet, Cemsix is available in four colour options, with matching accessories.

- 1 Traditional grey fibre-cement corrugated sheet
 - 2 Coloured corrugated sheet
- All sheets and fittings incorporate our unique 3 stage coating process.

Natural Grey

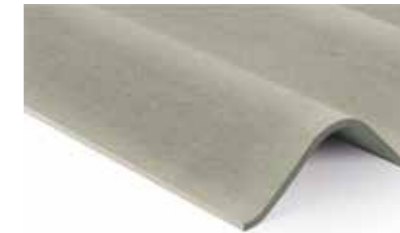

Blue/Black



Laurel Green



Van Dyke Brown



Features and benefits of fibre cement corrugated sheets



Corrosion resistant
Fibre cement is rust and rot free and able to cope with external weathering as well as the aggressive atmospheres within some livestock buildings.



Lower noise levels
Steel cladding materials generate high levels of wind chatter and rain drum. Fibre cement minimises these acoustic issues and creates a benign internal environment.



Reinforcement strips
These polypropylene strips are embedded in the sheets at manufacture to ensure compliance with ACR [M] 001:2014 "Test for Non-Fragility of Large Element Roofing Assemblies"



Condensation reduction
The absorbency of fibre cement prevents condensation formation and the dripping of water onto livestock or produce, again maintaining a benign environment.

Technical data

Available sheet lengths/weight per sheet		
1375mm (4'6")/20.78kg	2125mm (7')/32.12kg	2900mm (9'6")*/43.83kg
1525mm (5')*/23.05kg	2275mm (7'6")/34.39kg	3050mm (10')*/46.10kg
1675mm (5'6")*/25.32kg	2440mm (8')*/36.88kg	3660mm (12')*/55.32kg
1825mm (6')*/27.58kg	2600mm (8'6")*/39.30kg	
1975mm (6'6")/29.85kg	2750mm (9')*/41.57kg	
Overall width	1086mm	
Net covering width	1016mm	
Thickness (nominal)	6.0mm	
Density (nominal)	1700kg/m³	
Pitch of corrugations	146.5mm	
Overall depth	54mm	
Side lap	70mm	
Minimum end lap	150mm	

Maximum purlin centres	1375mm
Maximum rail centres	1825mm
Maximum unsupported overhang	350mm
Approximate weight of roof as laid, with 150mm end laps, single skin including fixings	17 kg/m ²
Minimum pitch	5°
Spaced roofing width trimmed	1000mm

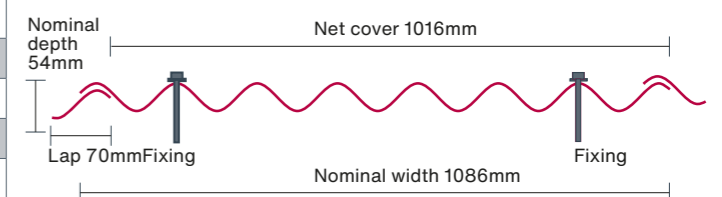

* Size available as translucent sheet

Cemsix corrugated accessories

1. Cemsix cranked crown ridge



To suit a variety of roof pitches. 3 Girths to provide smooth closure of roof apex.

Dimensions
Available in 750mm (12.5°, 15°)
Available in 900mm (5°, 10°, 12.5°, 15°, 17.5°, 22.5°).
Available in 1200mm (12.5°, 15°)
Available in 1800mm (12.5°, 15°, 17.5°, 22.5°)

2. Cemsix cranked crown ventilation ridge



Normally used in single-skin construction, particularly in agricultural buildings. This fitment may not be fully weatherproof in swirling snow or rain.

Dimensions
Available in 750mm (12.5°, 15°)
Available in 900mm (10°, 12.5°, 15°, 17.5°, 22.5°)
Available in 1200mm (12.5° & 15°) MADE TO ORDER
Available in 1800mm (12.5°, 15°, 17.5°, 22.5°)
Free air area: 800cm

3. Cemsix two-piece close fitting ridge



Two piece ridge fitting adjustable to roof pitches not covered by standard cranked crown ridges.

Dimensions
370mm wing
Net cover: 1016mm

¹ For roof pitches between 5° and 15°, it is necessary to trim the roll of the outer ridge wing on site to clear the corrugated portion of the inner ridge wing along the length of the ridge.

4. Two-piece adjustable ventilation ridge



Two piece ridge fitting adjustable to roof pitches not covered by standard cranked crown ridges, to provide ventilation.

Dimensions
1 Net cover: 1016mm
Wing: 370mm
Free air area: 800cm

¹ For roof pitches between 5° and 15°, it is necessary to trim the roll of the outer ridge wing on site to clear the corrugated portion of the inner ridge wing along the length of the ridge.

5. Cemsix two-piece plain wing ridge†



Two piece ridge fitting adjustable to roof pitches not covered by standard cranked crown ridges.

Dimensions
Wing: 350mm
Net cover: 1060mm

¹ For roof pitches between 5° and 15°, it is necessary to trim the roll of the outer ridge wing on site to clear the corrugated portion of the inner ridge wing along the length of the ridge.

6. Cemsix barge board



Used to close verge at gable ends. Nominal 200mm wing for single skin constructions and 300mm x 300mm for double skin.

Lengths:
200mm x 200mm x 2400mm or 3000mm
300mm x 300mm x 1600mm, 2400mm or 3000mm

7. Cemsix roll top bargeboard



Used to close verge at gable ends. Nominal 200mm wing for single skin constructions and 300mm x 300mm for double skin.

Dimensions
200mm x 200mm x 2500mm or 3000mm
Available in 300mm x 300mm, 1800mm, 2400mm or 3000mm

8. Cemsix cranked bargeboard



Closes verge apex when crown cranked ridge sheets are used.

Dimensions
Available in 200mm x 200mm wing at 1300mm girth (10°, 12.5°, 15°, 17.5°, 22.5°)
Available in 300mm x 300mm wing at 1300mm girth (10°, 15°)

9. Cemsix cranked roll top bargeboard



Closes verge apex when crown cranked ridge sheets are used.

Dimensions
Available in 1300mm girth 200mm x 200mm wing (10°, 12.5°, 15°, 17.5°, 22.5°)
300mm x 300mm wing (10°, 12.5°, 15°, 22.5°)

10. Two-piece roll top finial



Used in conjunction with roll top bargeboards and close fitting ridges.

Dimensions
200mm wing x 360mm deep

11. One-piece finial



Used in conjunction with plain wing bargeboard and close fitting ridges.

320mmx370mm

12. Plain wing angle ridge



Available in 300 x 300 wing and 240 x 240 wing 5° to 60° in 5° increments

Dimensions
Length: 1200mm
Net cover: 1080mm

13. Cemsix apron flashing piece



Used where cladding changes from pitched to vertical or where sloping roof abuts a brick wall.

Dimensions
1060mm left (shown) and right hand available
Net cover: 1016mm

14. Cemsix eaves filler

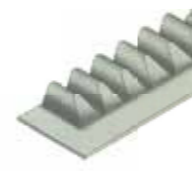

Used to prevent birds, vermin or wind driven particles entering at the eaves and provides a soffit to the underside of the sheets.

Dimensions
Net cover: 1016mm

15. Cemsix eaves closer



Used to prevent birds, vermin or wind driven particles entering at the eaves with a drip into the gutter.

Dimensions
Net cover: 1016mm
100mm upstand

16. Cemsix open ridge



Prevents rain ingress through ridge where sheets finish short to allow ventilation through apex of roof.

Dimensions
1500mm long with spigot
Net cover: 1350mm

17. Cemsix movement joint



Used in long stretches of roofing and cladding to allow for expansion or structural building movement.

Dimensions
Length: 3000mm
Net cover: 311mm

18. Cemsix cranked movement joint



Closes movement joint apex where movement joints are used.

Dimensions
Width: 330mm
Net cover: 1300mm

19. Translucent sheets



Used where increased light levels are required within structure.

Fix each translucent sheet through every full corrugation to each purlin, with standard corrugated sheet fixings.

Side-stitch the translucent sheet with stitch bolt every 300mm to 400mm to the adjacent Cemsix sheet.

Dimensions
Net cover: 1016mm
Available in selected sizes lengths corresponding to Cemsix sheet lengths between 1525mm & 3660mm

Performance

Condensation and rust resistance

Cemsix Corrugated sheets and accessories are manufactured from fully compressed fibre cement. Unlike steel, fibre cement is not susceptible to rust and the degradation in appearance and performance that rust causes, particularly around fixings at lower laps of sheets, leading to increased repair and maintenance costs.

Rain drum and animal welfare

Fibre cement has a far higher level of acoustic absorption than steel and does not transmit rain impact noise or the noises caused by wind chatter so readily. This means less disturbance to the livestock within, happier animals and improved health and productivity.



Health and Safety

The sheets incorporate polypropylene reinforcing strips for enhanced safety. They have been tested for fragility in accordance with ACR [M] 001:2014 "Test for Non-Fragility of Large Element Roofing Assemblies" (to class C) Impact Resistance Test Method and BS EN 15057:2006 Fibre Cement Profiled Sheets.

Any roof or wall clad in sheets should be treated as fragile. Care must be taken when working on roofs and the precautions detailed in BS 5502-20:90 regarding permanent walkways must be followed.

Strength

The sheets are denoted Class C1X, having a minimum breaking load of 4250Na and conform with the requirements of BS EN 494:2012+A1:2015.

Fire

When tested in accordance with BS 476-3:1958 sheets achieve an EXT.S.AA designation. When tested in accordance with BS 476-6:1989 and BS 476-7:1997 sheets had a fire propagation index of ≤ 3.5 , a sub-index of ≤ 0.6 and a Class 1 surface. The sheets have a Class 0 surface and are deemed low risk and unrestricted by the requirements of National Building Regulations.

Durability guarantee

Evidence indicates that sheets should have a life far in excess of 30 years, with paint colour stability of 10 years. As with all cementitious material, the sheets will cure and weather over time. A 30 year guarantee is available on application.

Installation

Cemsix corrugated sheets are installed in accordance with BS 5502-21:1990, BS 5427:2016+A1:2017 and BS 8219:2001+A1:2013



Design

Cemsix corrugated sheet can be fixed to steel, concrete or timber purlins. Fixing holes should be predrilled, or self-drilling, self-tapping top fix fixings can be used (see page 25). Fixing should be undertaken according to BS 8219:2001+A1:2013

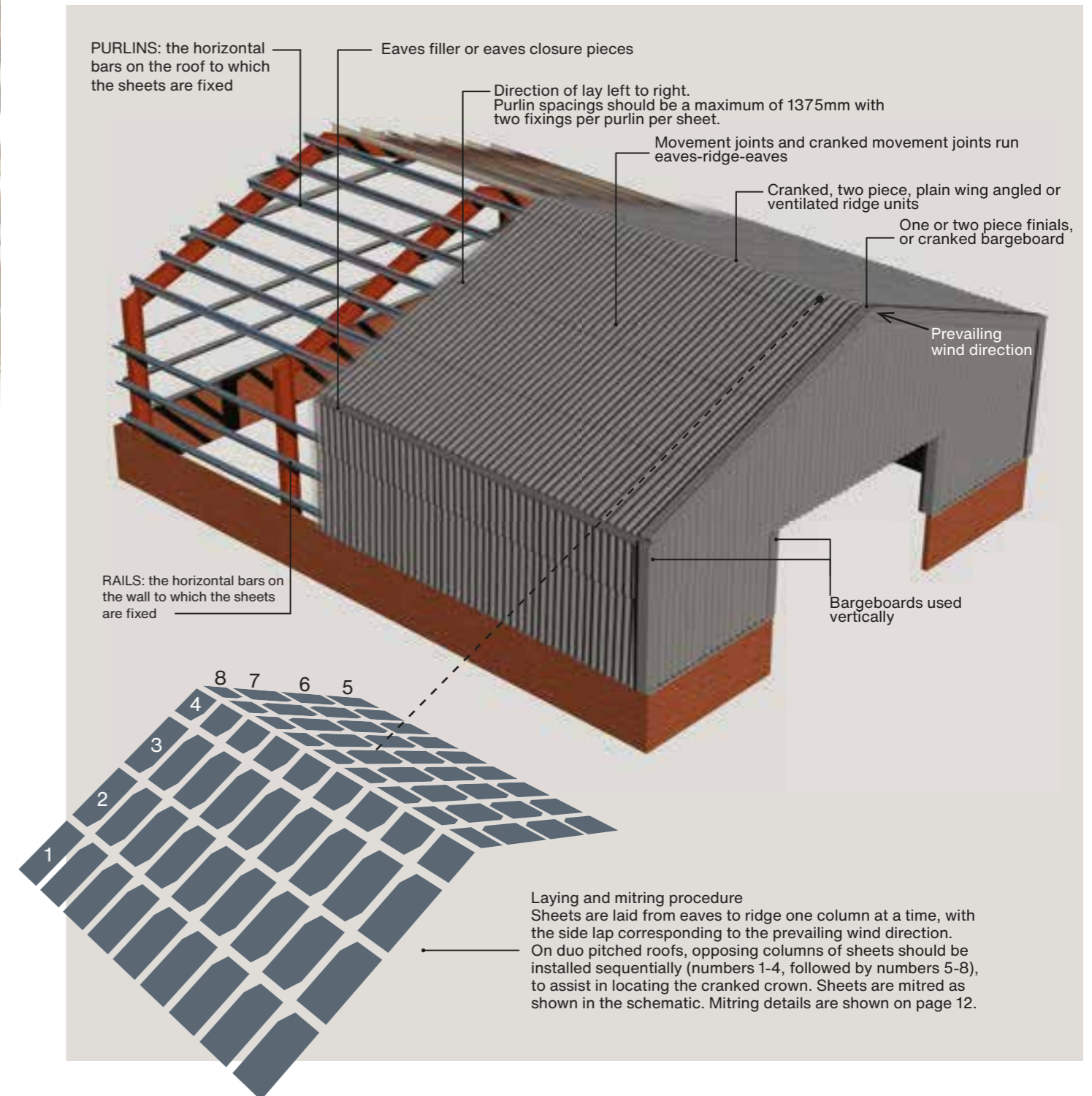

Mitring scheme

To avoid 4 layers of overlapping roof sheets, the corners of two sheets must be mitred.

Each mitre must be cut straight and cleanly either by hand or by power saw. The angle and size of mitre is governed by the end and side lap dimensions. It is recommended that a good quality butyl mastic strip is used to seal the overlapping sheets to provide a weatherproof joint. Two corners of opposing sheets should be mitred the equivalent of the head and side lap (i.e. maximum 70mm x 150mm) with a gap between sheets of 3-6mm.

Sheets on the perimeter of the roof will have one mitre (except the first and last sheets which remain complete), all other sheets will therefore have two mitres.

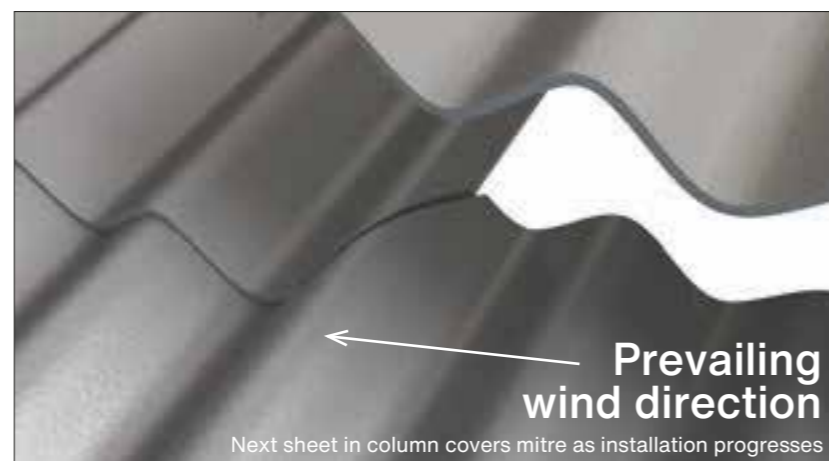
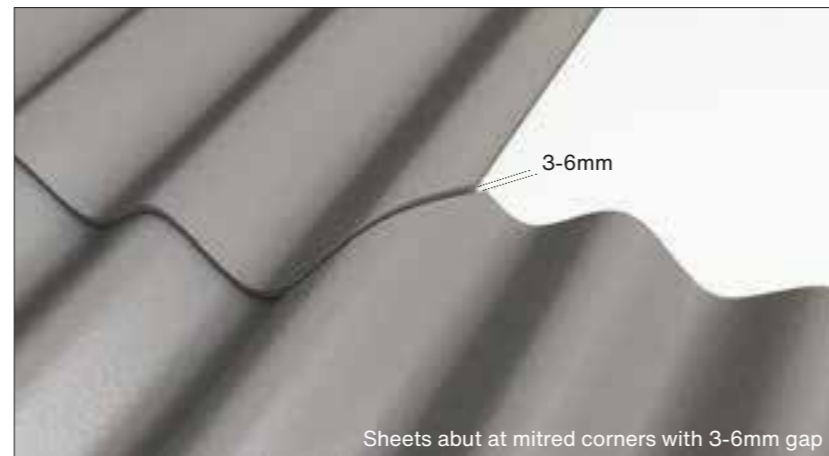
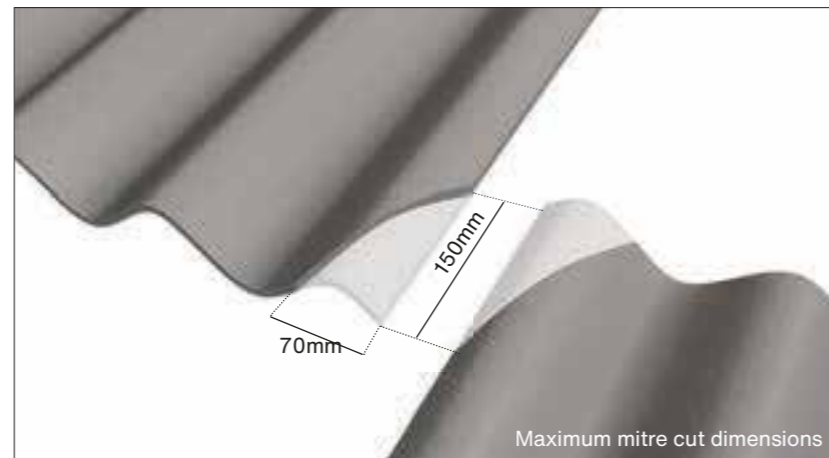

Overlap sealing

Where required, overlaps should be sealed using a pre-formed 8mm diameter mastic ribbon of butyl or a polyisobutylene based material, creating a windproof joint and protecting the fixing holes from wind driven precipitation.

See page 15 for more details on sealing requirements.

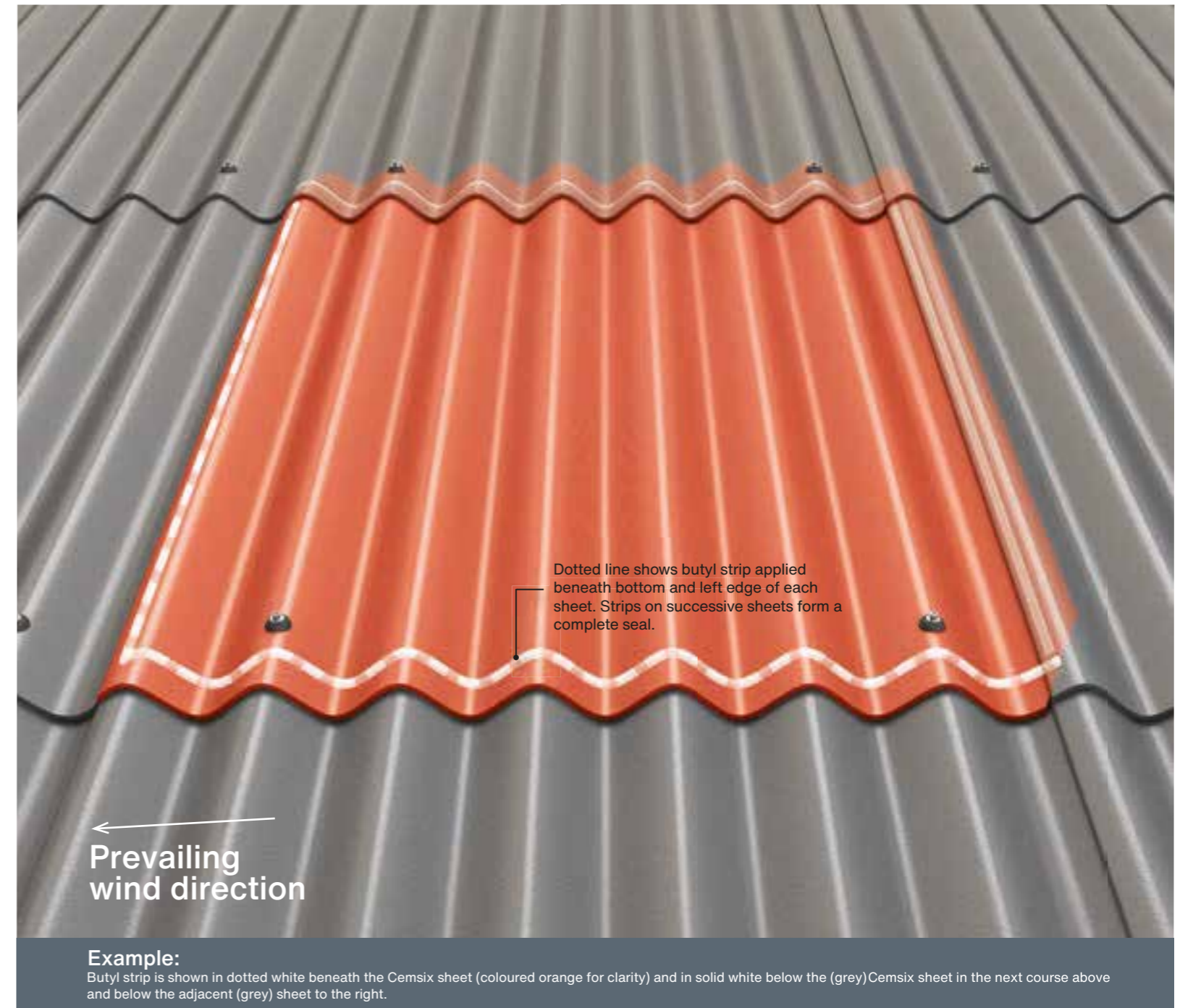

Exposure and windloadings

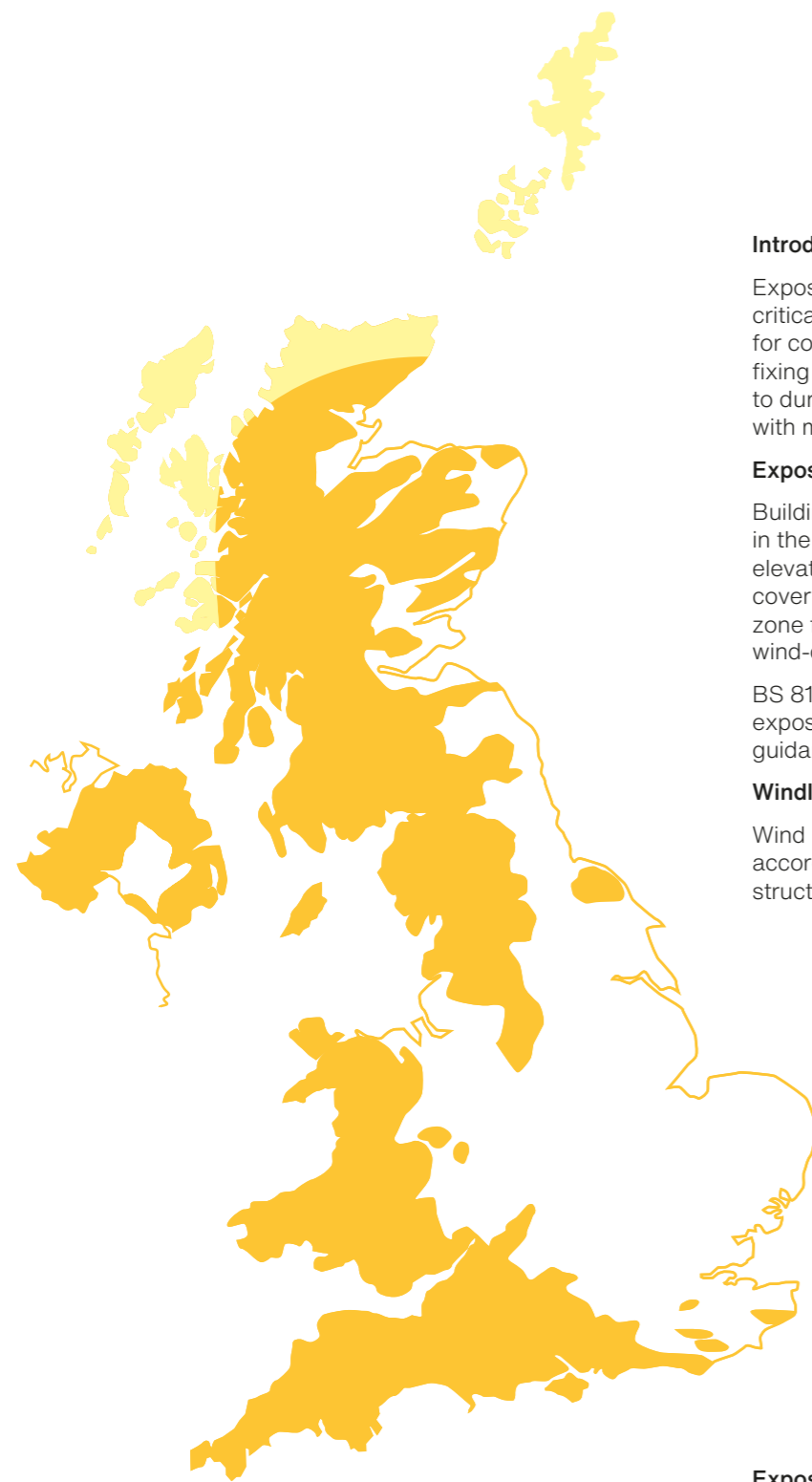

Introduction

Exposure, prevailing wind direction and wind loading are critical criteria in the design and specification process for corrugated sheeting, as they dictate lap, sealing and fixing specifications. Correct specification leads, in turn, to durable, secure and cost effective roofs (and walls) with minimal maintenance requirements.

Exposure

Buildings located in open countryside with roofs or walls in the direct path of prevailing winds - such as coastal or elevated sites, or site unprotected by trees or other local cover - will be subject to severe exposure. The exposure zone for your building can be established from the wind-driven rain map, left

BS 8104: 1992 'Code of practice for assessing exposure of walls to wind-driven rain' offers guidance on assessing exposure to wind-driven rain.

Windloadings

Wind loading must be calculated and designed for in accordance with BS EN 1991 Eurocode 1: Actions on structures - Part 1-4: General actions - Wind actions.

Exposure Zones

Approximate volume of wind-driven rain (litres/m²) per spell:

less than 56.5
 more than 56.5
 Highlands and Islands

Note: from BS 8219



Sheltered to moderate sites

Less than 56.5 l/m² of wind-driven rain per spell

Minimum roof pitch	Minimum end lap	End laps treatment	Side laps treatment
≥ 22.5	150mm	Unsealed	Unsealed
≥ 15°	300mm	Unsealed	Unsealed
≥ 15°	150mm	Sealed	Sealed
≥ 10°	150mm	Sealed	Sealed
≥ 5°*	300mm	Double Sealed	Sealed

*The minimum pitch for Cemsix corrugated sheet is 5°. On roof pitches between 5° and 10° the maximum slope length is 15m. For longer spans please contact Swisspearl for advice.

Moderate to severe sites

More than 56.5 l/m² of wind-driven rain per spell

Minimum Roof pitch	Minimum end lap	End laps treatment	Side laps treatment
≥ 25°	150mm	Unsealed	Unsealed
≥ 17½°	150mm	Sealed	Unsealed
≥ 15°	150mm	Sealed	Sealed
≥ 10°	300mm	Sealed	Sealed
≥ 5°*	300mm	Double Sealed	Sealed

*The minimum pitch for Cemsix corrugated sheet is 5°. On roof pitches between 5° and 10° the maximum slope length is 15m. For longer spans please contact Swisspearl for advice.



Design detailing

The overlaps on low pitched roofs should be sealed with butyl strips, creating a windproof joint and protecting the fixing holes from wind driven precipitation.



Bargeboards

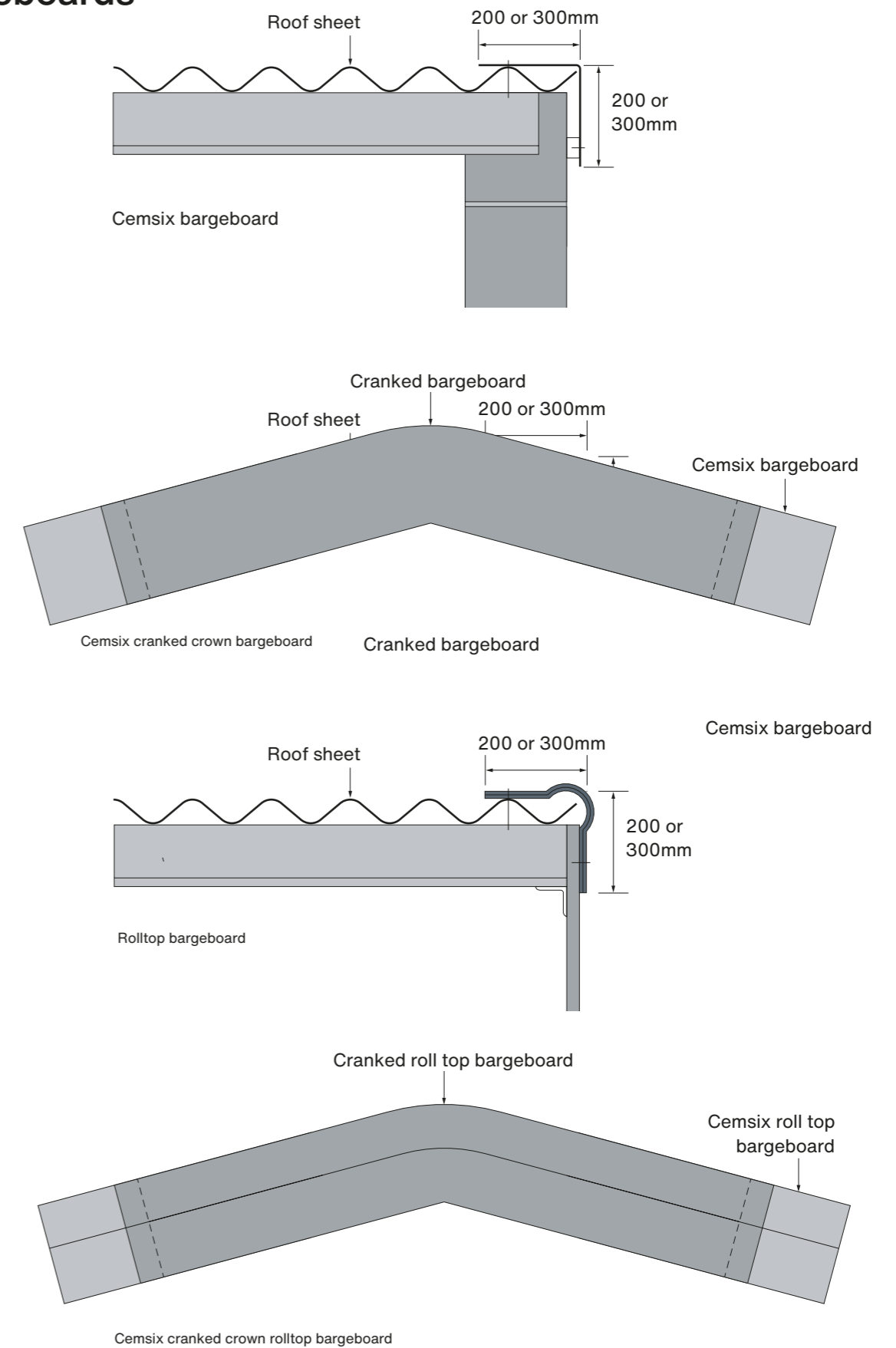

Design detailing

Ridges

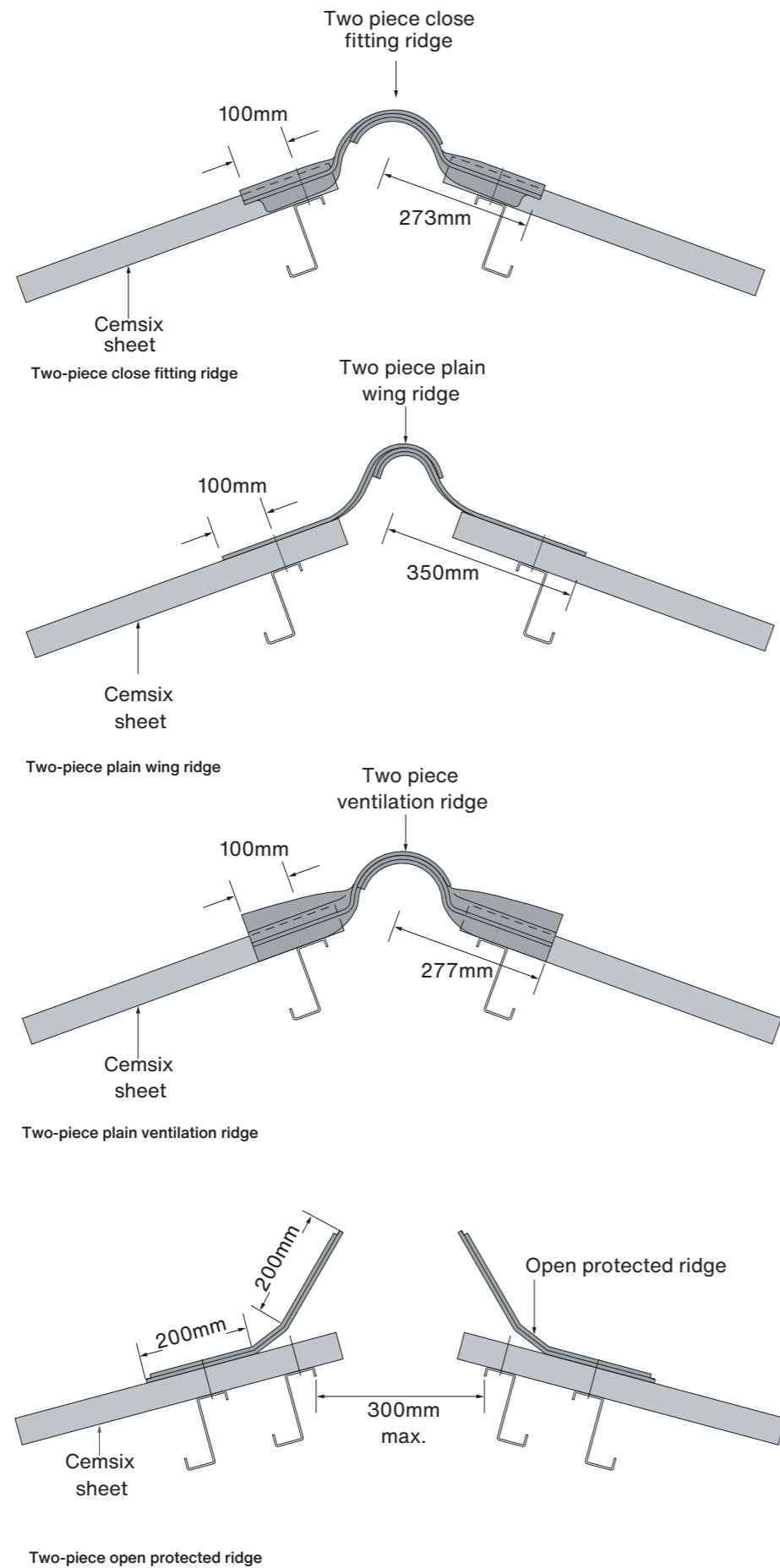

Design detailing

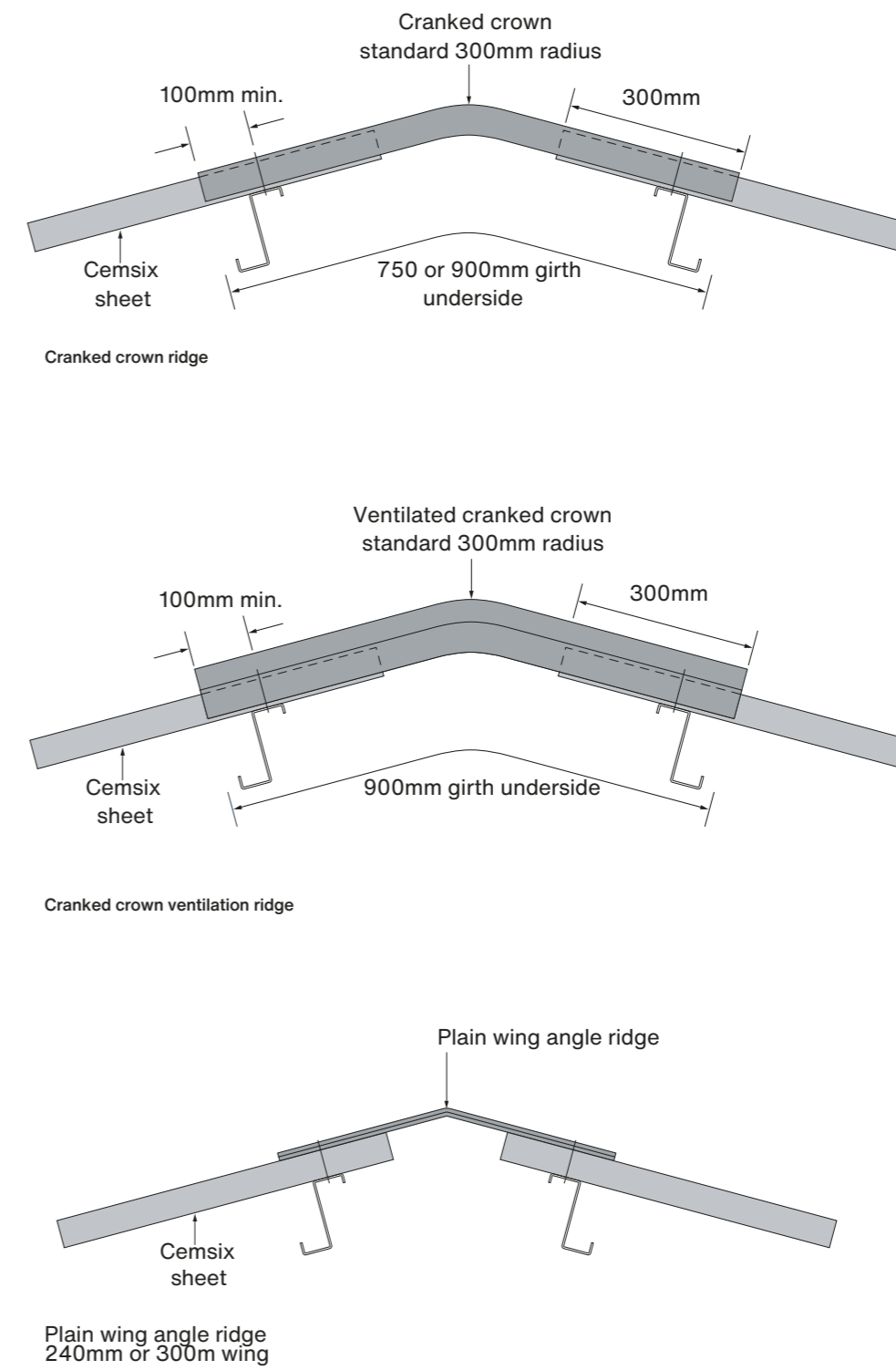

Design Specifications

Finials

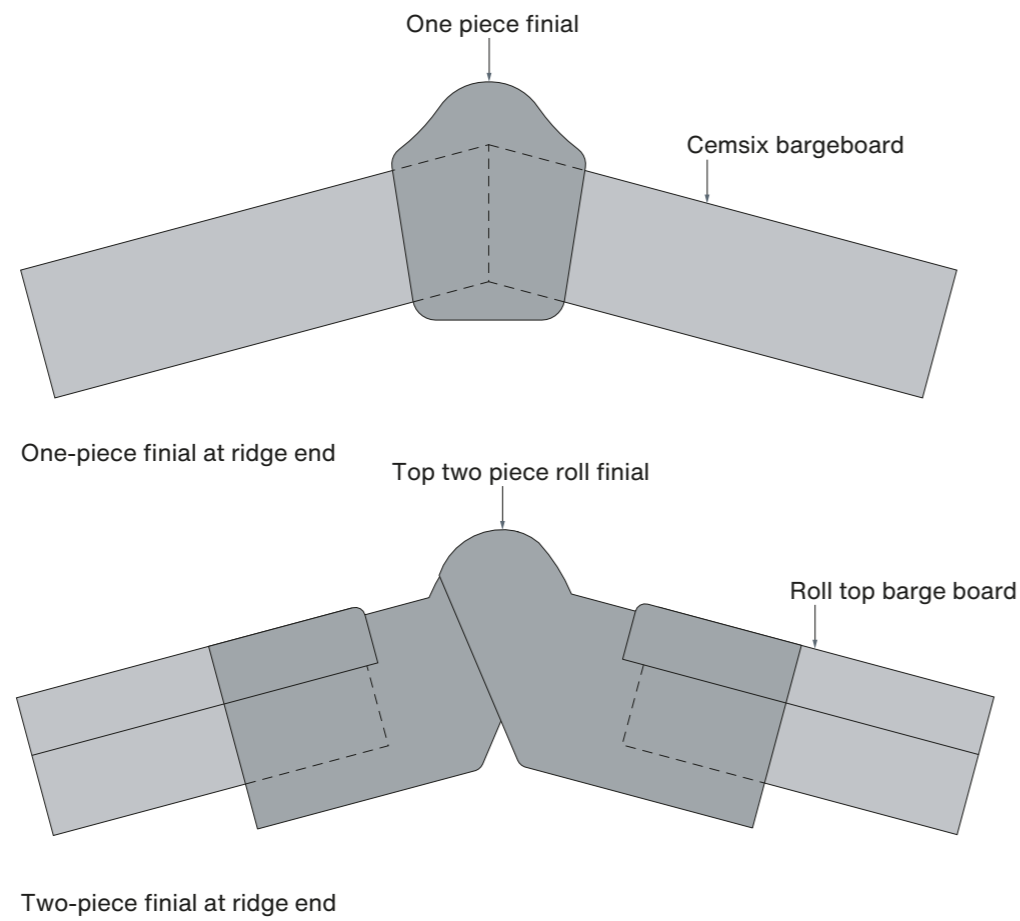

Eaves

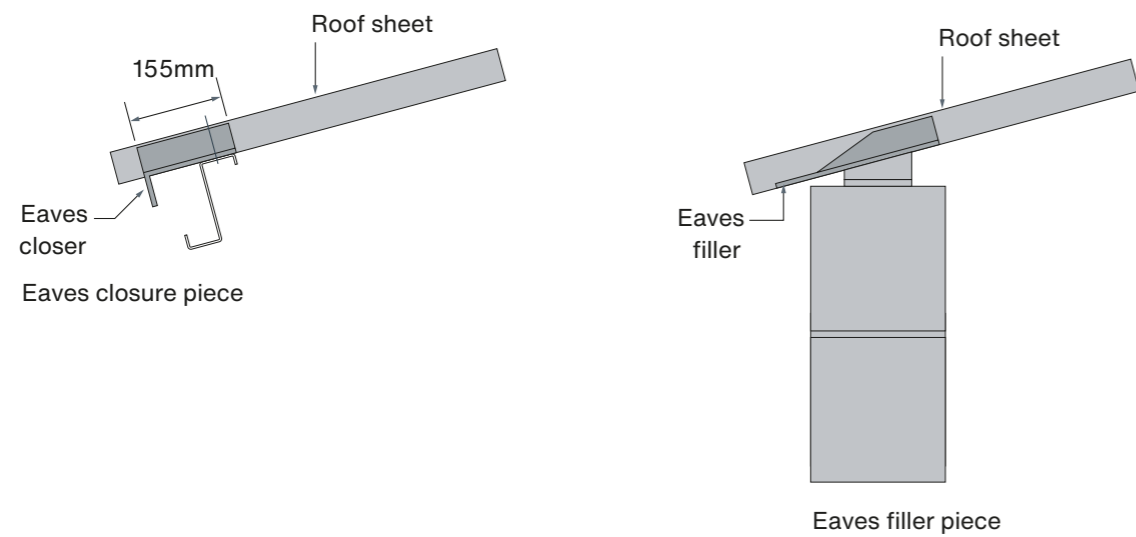

Design Specifications

Apron flashing

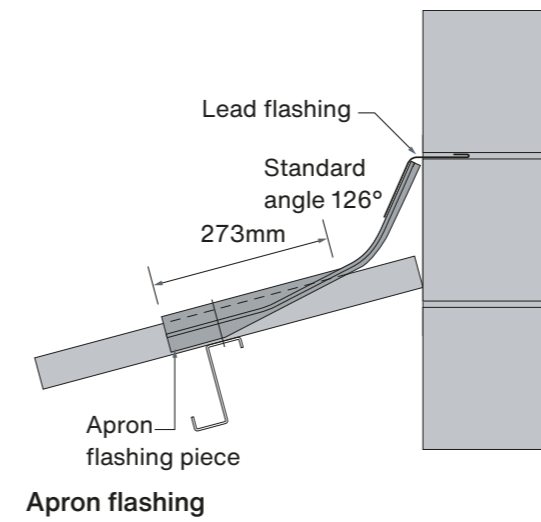

Movement joints

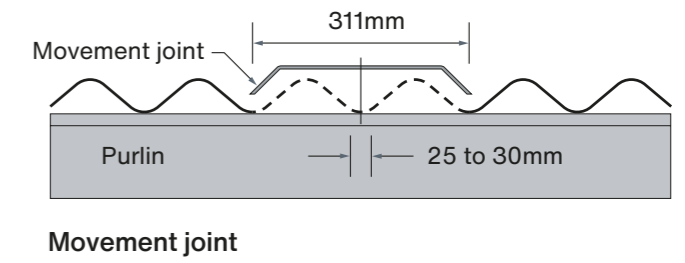

Vertical cladding

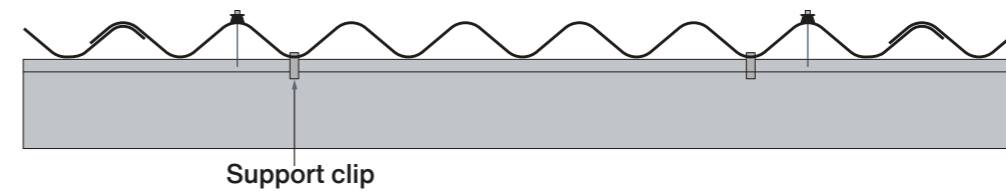

Crest-fixed vertical cladding.
Provision should be made for supporting the sheets at their base with clips when fixing through the crest for vertical applications.

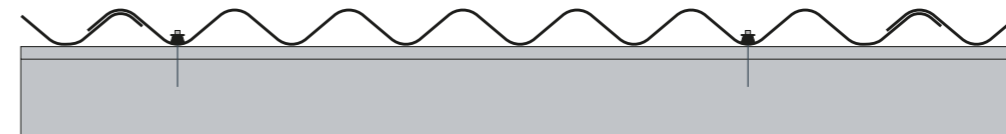

Valley-fixed vertical cladding.
No support clips are necessary with this fixing method.

Ventilation



Crank crown vent ridge

Ridge ventilation units

Single part (cranked crown vent ridge shown, left) or two-part pre-fabricated ridge fittings are available to introduce ventilation to buildings at ridge level.

These components are completely compatible with all other Cemsix corrugated components.

Crank crown and 2 piece ridge vents give 800cm² air gap per unit, therefore a free air area of 80,000mm²/m run.

Two-part adjustable vent ridge

Two piece ridge fitting adjustable to roof pitches not covered by standard cranked crown ridges, to provide ventilation. These units provide 800cm² air gap per unit.



Spaced roofs

Where very high levels of ventilation are required, spaced roofing can be considered.

This type of roofing removes the need for mitring.

The high ventilation level is complemented by additional natural light.

This method should not be used where rain penetration in severe weather conditions may be detrimental to the contents.

Spaced roofs offer a free air area of 15-25000mm²/m run air gap.

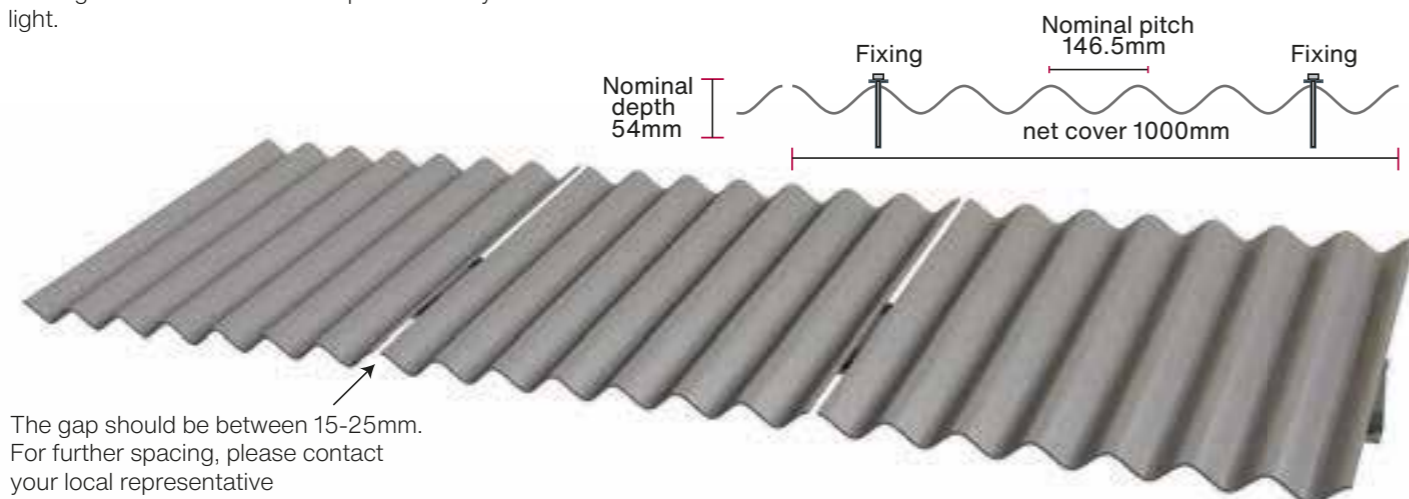

The gap should be between 15-25mm. For further spacing, please contact your local representative



Breathing roofs

This type of ventilation is achieved by elevating columns of corrugated sheets using a 50mm x 25mm treated timber batten. Battens are located at the horizontal overlap for each course. Using this sized batten, a breathing roof offers a free air area of 46,000mm²/m run. This type of roofing eliminates the need for mitring.

Open ridges

Open ridges provide ventilation at the apex of the roof using the 'stack effect' and are therefore particularly efficient at removing saturated air from within the building. Open ridges lend themselves to use on livestock buildings.

With a 300mm max gap, an open ridge system offers a free air area of 304,800mm²/m

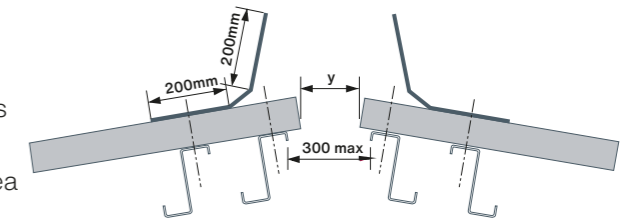

Sheet fixing

Pre-drilling

Every sheet should be twice fixed at each purlin.

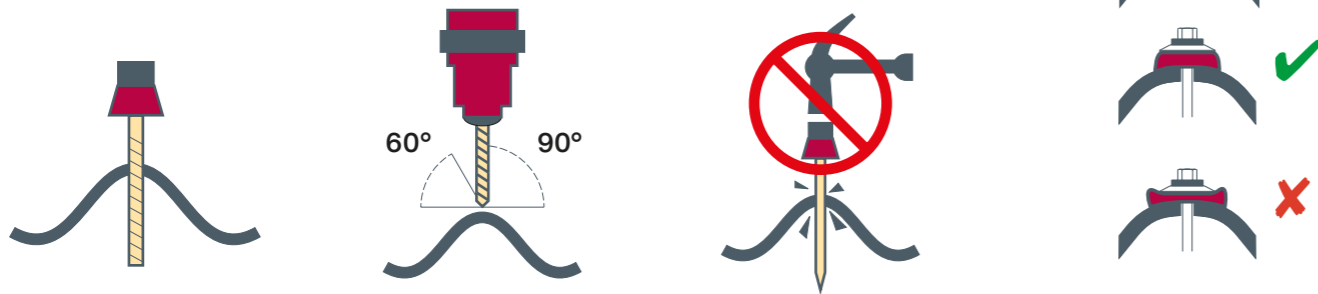

It is extremely important that the correct roof purlins/rail system, type of fixing and washers are selected, to eliminate leakage/corrosion and the general deterioration of the construction.

It is recommended that a self-drilling Top-Fix screw is adopted. This simple method offers a fast, low-cost fixing solution. Using a high-speed screw gun, drive in the fixing. The fixing system is only suitable for roofs up to and including 30° pitch.

Site dust

If cutting or drilling sheets is likely to result in dust generation, adequate ventilation and/or protection must be provided. Health and Safety Executive Guidance Note EH 44 Dust in the Workplace: general principles of protection should be followed.

Using a tungsten carbide tipped drill at 90° angle to the sheet, drill a hole 2mm larger than the selected fixing. The drill point should be no less than 60° to the sheet. Always drill at the 'apex' of the profile. Do not fix a sheet in the 'valley' or on a 'slope' of the profile.

NEVER hammer fixing through the sheet. This will invalidate the guarantee. Fibre-cement sheets will shatter under impact and subsequently allow water to penetrate the apparent fixing. ALWAYS pre-drill.

To achieve a watertight and weathertight seal, it is important to confirm that the sealing washer is correctly tightened. Not over tight, not too loose. After a period of time, when the material has settled, the fixings may require re-tightening with hand tools. Be sure to use roof ladders to avoid walking on the roof sheets.



Use of fixings

Roofing

For normal roofing applications, the fixing procedure should be as follows:

Pre-drill a hole 7mm larger than the fixing diameter.

- i) For light section purlins, use DF3-FCW-5.5 x 45 or similar.
- ii) For heavy section steel purlins, use DF12-FCW-5.5 x 60 or similar.
- iii) For timber purlins, use DFT-FCW-6.5 x 65 or similar.

Please see page 21 for fixing positions.

Vertical cladding

If it is desired to top fix sheets as shown in the above photograph, pre-drill a pilot hole 7mm in diameter and use:

- i) For light section rails, use DF3-FCW-5.5 x 75, or similar.
- ii) For heavy section rails, use DF12-FCW-5.5 x 80, or similar.
- iii) For timber rails, DFT-FCW-6.5 x 80 on timber.

In addition, support the base of each sheet with 2 clips hooked over the sheeting rail in the valley of the sheet, adjacent to the fixing.

Valley fixed vertical cladding does not require additional support clips.

Please see page 21 for fixing positions.

The following screws and washers are available ex-stock:



105mm screws for thin Zed purlins between 1.6mm and 2.5mm - DF3 -FCW 5.5 x 45 (75 for vertical).



130mm screws for timber purlins - DF3 -FCW 6.5 x 65 (80mm length for vertical).



Laplok
38 mm, Sealing Washer
28 mm Poppy Red

Storage and handling

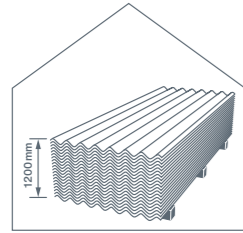

1. Coloured sheets and accessories should be stored internally. Until the sheets are in position on the building they could be subject to damage from site debris and accidental collision.

Rainwater, condensation and extreme weather conditions can also adversely affect the sheets (particularly coloured sheets) during storage.

2. Stacks without additional timber cross bearers should not exceed 1200mm. Cross bearers should be no more than one metre apart. Different length sheets should ideally be stacked separately, but if stacked up, they must be laid vertically on the top and their cross bearers must line up.

3. The sheets are supplied covered in shrink-wrapping. It is strongly recommended that the wrapping is NOT removed until the sheets are required for fixing. Should any sheets remain at the end of the working period, the edges must be covered.

4. If several stacks are to be laid one on top of the other, timber cross bearers should be placed at 50mm intervals up to a maximum height of 300mm. It is important that the ground is level and firm.

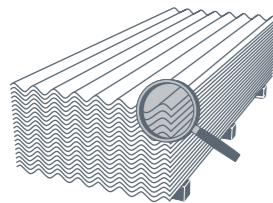

With a natural grey product, if it is stored outside, the stacks should be regularly inspected to ensure the moisture has not penetrated the coverings. Coloured sheets should only be stored inside and are particularly vulnerable at this stage.

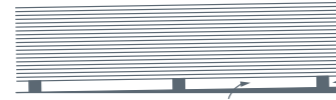

If it is not possible to store the product inside a building, a suitable site should be selected. The ground should be firm and level and as close to the construction work as possible. The sheets must be stacked on cross bearers, thus raising them off the ground.

A simple protective frame should be constructed and covered with a waterproof material. Air must be allowed to circulate all round the stack. The whole frame and stack should be tilted to encourage rainwater to drain freely.

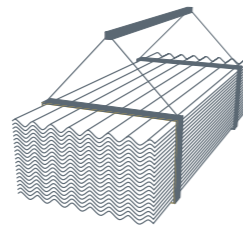

Crane handling should be careful to avoid damage to the edges of the sheets. Use rope slings (not chains) and over-width spreaders to eliminate the possibility of damaging the edges of the sheets.

The corners of the sheets are particularly vulnerable during transportation.

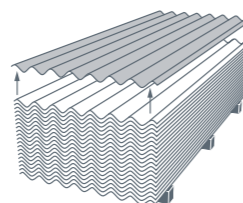

Never push, drag or slide a sheet from a stack. Always consciously remove the sheet by lifting from the stack. Similarly lift the sheet into position on a roof, do not push or drag over the purlins or other roof sheets.



Manufacturer's Warranty



Swisspearl Warranty



Lightweight



Weather Resistant



Non Combustible



Long Lasting



Noise Reducing



Invest in quality

- Cemsix fully compressed high density corrugated sheet resists abrasion
- Swisspearl's 3 part painting process gives superior finish on painted sheets
- High dimensional tolerance for neat alignment of sheets on the roof slope
- Full range of accessories includes; ventilation, ridges cranked crowns and closers
- Translucent sheets

